

1A LED DRIVER WITH INTERNAL SWITCH

Description

The PAM2861 is a continuous mode inductive step-down converter, designed for driving single or multiple series connected LEDs efficiently from a voltage source higher than the LED voltage. The device operates from an input supply between 6V and 40V and provides an externally adjustable output current of up to 1A. Depending upon supply voltage and external components, this can provide up to 30 watts of output power.

The PAM2861 includes the output switch and a high-side output current sensing circuit, which uses an external resistor to set the nominal average output current.

Output current can be adjusted below the set value, by applying an external control signal to the VSET pin.

The VSET pin will accept either a DC voltage or a PWM waveform.

The soft-start time can be increased using an external capacitor from the VSET pin to ground. Applying a voltage of 0.2V or lower to the VSET pin turns the output off and switches the device into a low current standby state.

Features

- Simple Low Parts Count
- Internal 40V NDMOS Switch
- 1A Output Current
- Single Pin On/Off and Brightness Control Using DC Voltage or PWM
- Soft-Start
- High Efficiency (up to 97%)
- Wide Input Voltage Range: 6V to 40V
- Output Shutdown
- Open LED Protection
- Short LED Protection
- Up to 1MHz Switching Frequency
- Inherent Open-Circuit LED Protection
- Typical 5% Output Current Accuracy
- Pb-free TSOT25 and SOT89-5 Packages

Pin Assignments

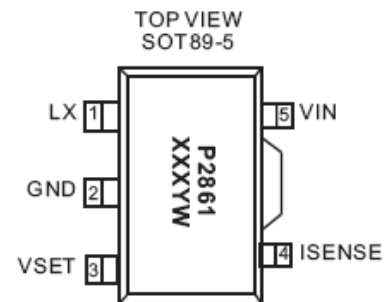
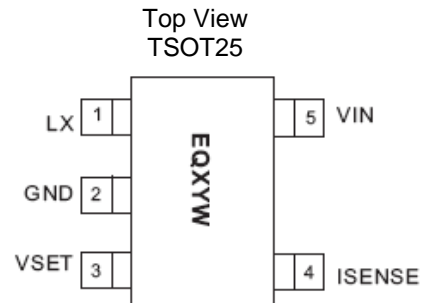

Applications

- Low voltage halogen replacement LEDs
- Low voltage industrial lighting
- LED back-side lighting
- Illuminated signs

Typical Applications Circuit

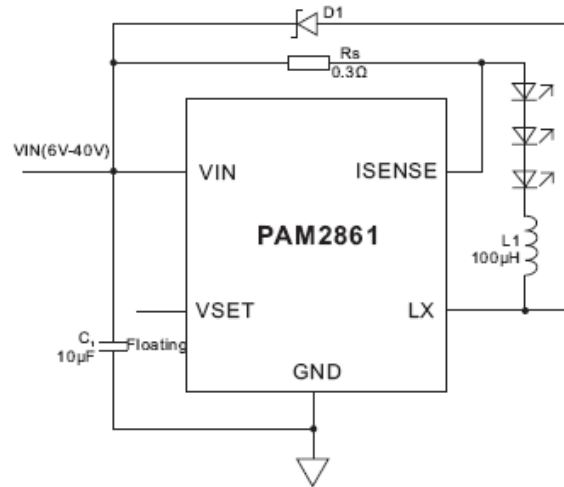

Pin Descriptions

Pin Number	Pin Name	Function
1	LX	Drain of NDMOS switch.
2	GND	Ground (0V)
3	VSET	<ul style="list-style-type: none"> Multi-function On/Off and brightness control pin: Leave floating for normal operation. Drive to voltage below 0.2V to turn off output current Drive with DC voltage ($0.3V < VSET < 2.5V$) to adjust output current from 12% to 100% of I_{OUTNOM} Drive with PWM signal from open-collector or open-drain transistor, to adjust output current. Adjustment range 1% to 100% of I_{OUTNOM} for $f < 500Hz$ Connect a capacitor from this pin to ground to increase soft-start time. (Default soft-start time = 0.1ms. Additional soft-start time is approx. 1.5ms/1nF)
4	ISENSE	Connect resistor R_S from this pin to VIN to define nominal average output current $I_{OUTNOM} = 0.1/R_S$
5	VIN	Input voltage (6V to 40V). Decouple to ground with 10µF or higher X7R ceramic capacitor close to device.

Thermal Information

Parameter	Package	Symbol	Max	Unit
Thermal Resistance (Junction to Ambient)	TSOT25	θ_{JA}	250	°C/W
	SOT89-5		160	
Thermal Resistance (Junction to Case)	TSOT25	θ_{JC}	130	
	SOT89-5		45	

Electrical Characteristics (@ $T_A = +25^\circ\text{C}$, $V_{IN} = 16\text{V}$, unless otherwise specified.)

Parameter	Symbol	Test Conditions	Min	Typ	Max	Units
Input Voltage	V_{IN}		6		40	V
Output Current	I_{LED}	$R_S = 0.3\Omega$		333		mA
		$R_S = 0.1\Omega$		1		A
Shutdown Current	I_{SD}	VSET Pin Grouded		20	40	μA
Quiescent Current without Switching	I_Q	VSET Pin Floating, $V_{IN} = 16\text{V}$		0.6		mA
Mean Current Sense Threshold Voltage	V_{SENSE}	Measured on I_{SENSE} Pin with Respect to V_{IN}	95	100	105	mV
Sense Threshold Hysteresis	V_{SENSE_HYS}			± 13		%
ISENSE Pin Input Current	I_{SENSE}	$V_{SENSE} = V_{IN} - 0.1$		8		μA
VSET Range on VSET Pin	V_{EN}	For DC Dimming	0.3		2.5	V
DC Voltage on VSET Pin to Enable	$V_{EN(ON)}$	V_{EN} Rising		0.25		V
DC Voltage on VSET Pin to Disable	$V_{EN(OFF)}$	V_{EN} Falling		0.2		V
LX Switch On Resistance	R_{LX}	@ $I_{LX} = 100\text{mA}$		0.3		Ω
LX Switch Leakage Current	$I_{LX(LEAK)}$				5	μA
Soft Start Time	T_{SS}	$V_{IN} = 16\text{V}$, $C_{EN} = 1\text{nF}$		1.5		ms
Operating Frequency	F_{LX}	$V_I = 16\text{V}$, $V_O = 9.6\text{V}$ (3 LEDs) $L = 47\mu\text{F}$, $\Delta I = 0.25\text{A}$ ($I_{LED} = 1\text{A}$)		233		kHz
Recommended Minimum Switch ON Time	T_{ON_REC}	For 4% Accuracy		500		Ns
Recommended Maximum Switch Frequency	$F_{LX(MAX)}$				1.0	MHz
Max Duty Circle				98		%
Recommended Duty Cycle Range	D_{LX}		25		75	%
Internal Comparator Propagation Delay	T_{PD} (Note 1)			45		ns
Over Temperature Protection	T_{OTP}			150		°C
Temp Protection Hysteresis	T_{OTP_HYS}			40		°C
Current Limit	$I_{XL(MAX)}$	Peak Inductor Current	1.5			A

Note: 1. Parameters are not tested at production, but guaranteed by design. V_{SENSE} : level A: 95mV to 100mV; level B: 100mV to 105mV.

Typical Performance Characteristics (@ $T_A = +25^\circ\text{C}$, $V_{IN} = 16\text{V}$, unless otherwise specified.)

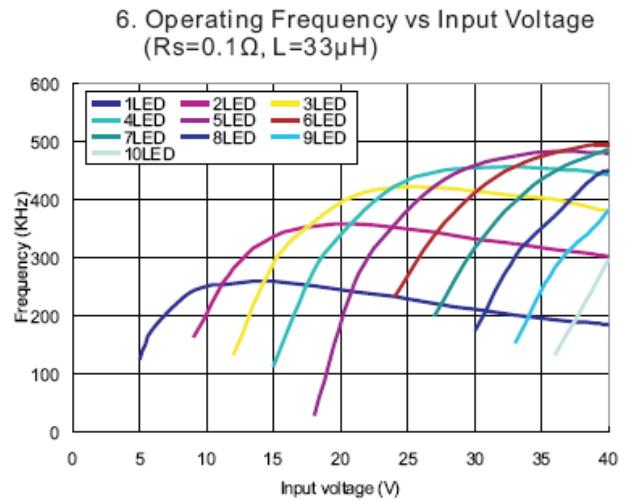
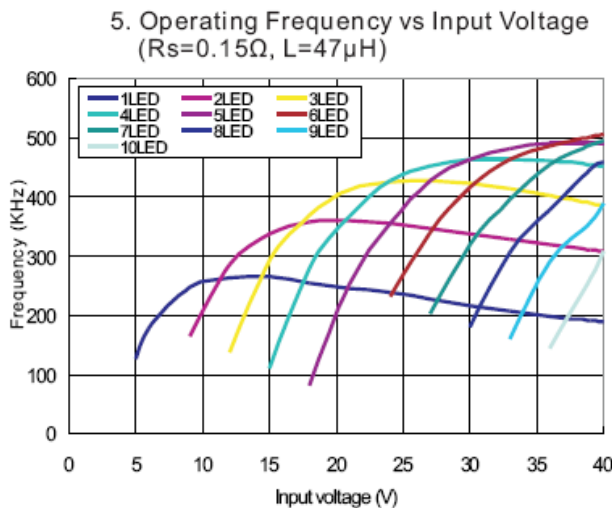
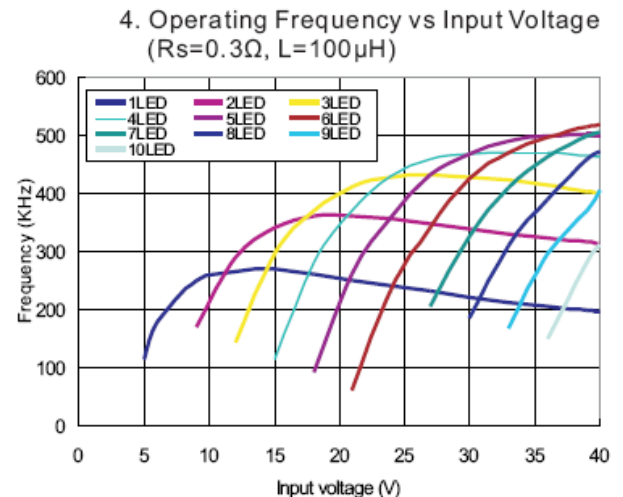
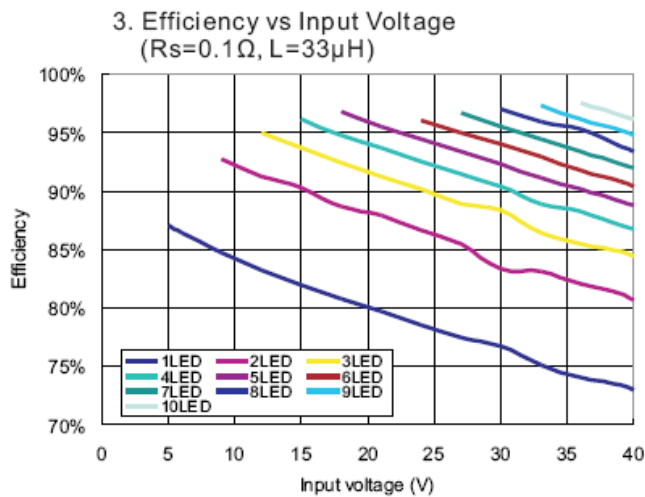
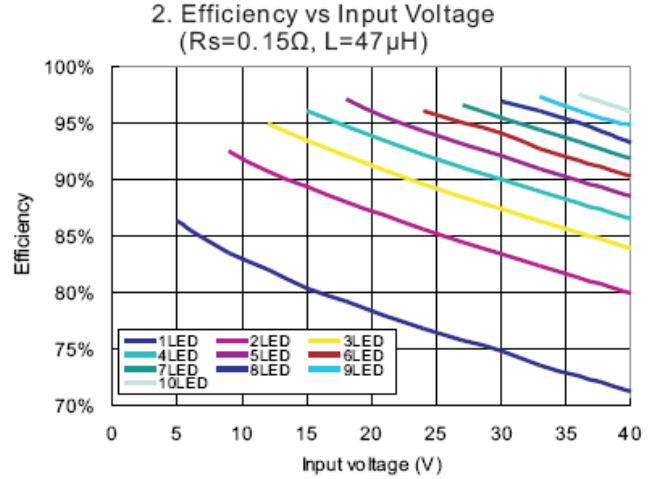
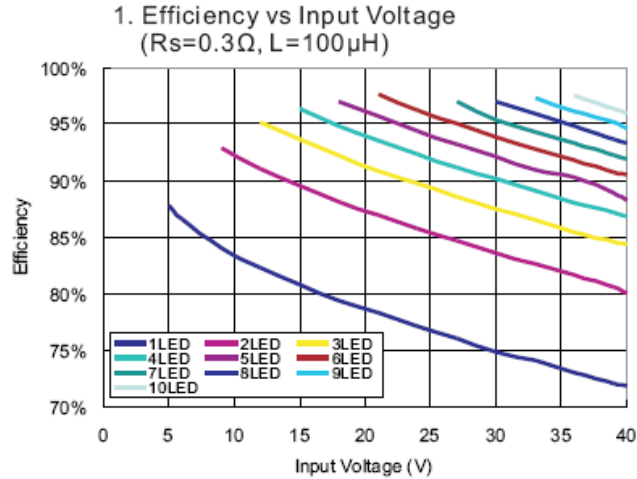

Typical Performance Characteristics (cont.) (@T_A = +25°C, V_{IN} = 16V, unless otherwise specified.)

7. Quiescent Current VS. Input Voltage

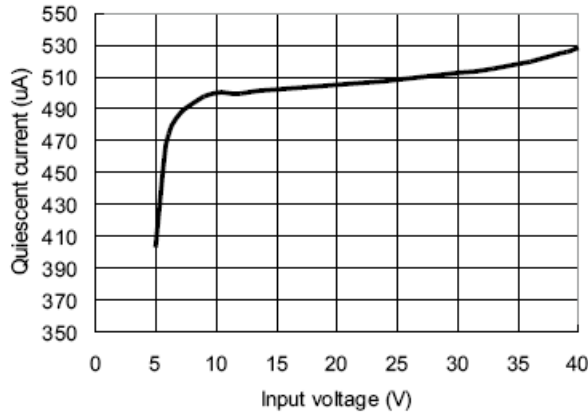

8. Shutdown Current VS. Input Voltage

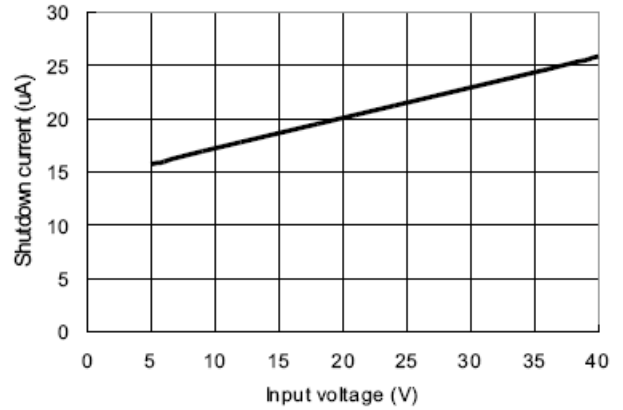

9. Feedback Voltage VS Vin

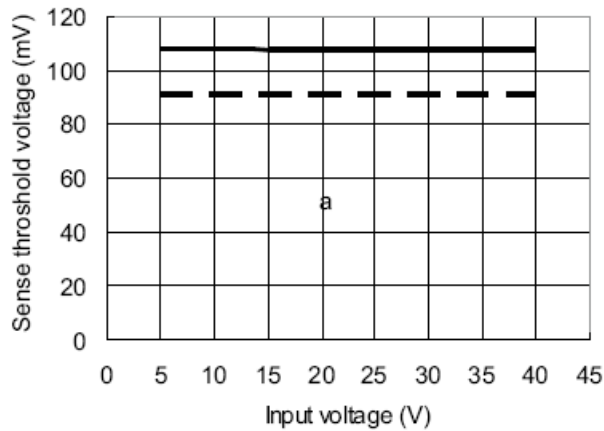

10. Duty Cycle VS LED Current (PWM=200Hz)

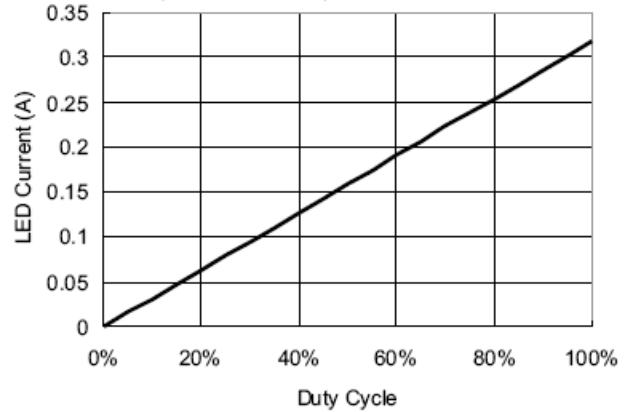

11. I_{LED} vs V_{SET}
(V_{IN}=16V, 3 LEDs, 100μH, R_s=0.3Ω)

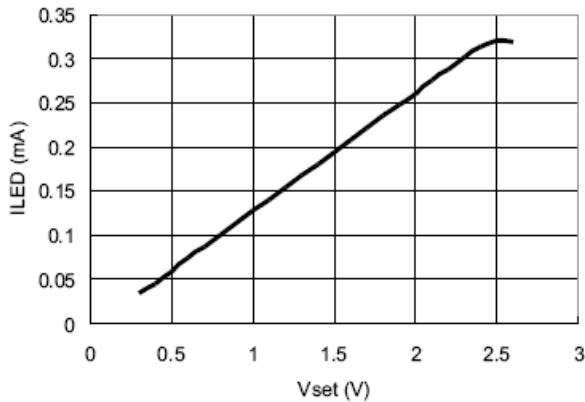

12. I_{LED} vs V_{SET}
(V_{IN}=16V, 3 LEDs, 47μH, R_s=0.15Ω)

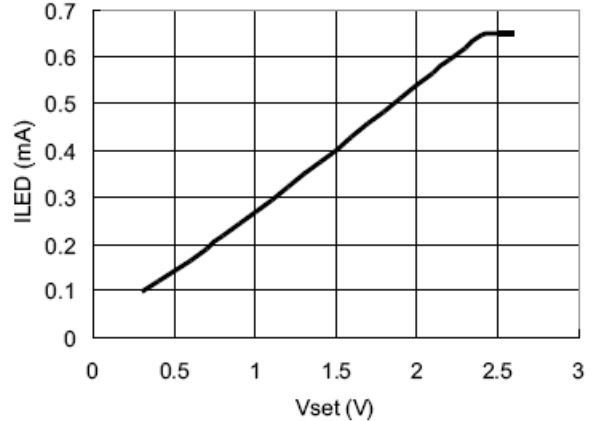

Typical Performance Characteristics (cont.) (@T_A = +25°C, C_{IN} = 10μF, C_O = 10μF, L = 4.7μH, unless otherwise specified.)

13. Steady State Waveforms



14. Start up Waveforms

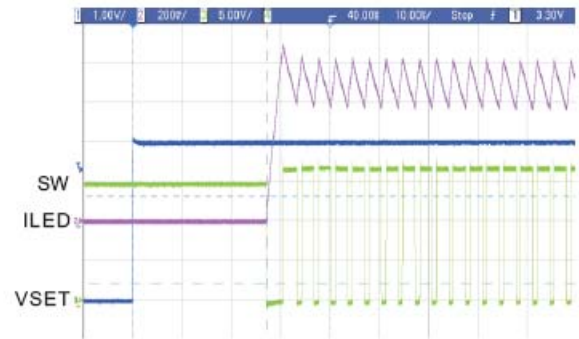

15. Dimming Waveforms (PWM=50%)



16. Pulse skip mode

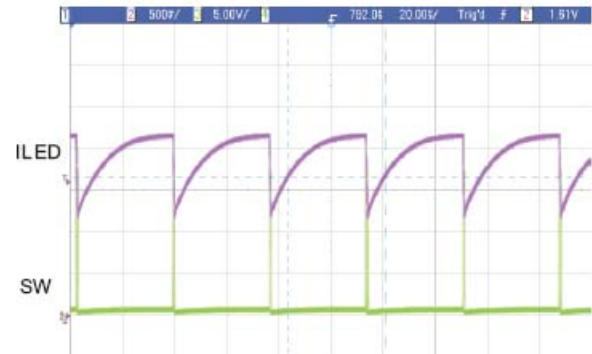

Application Information

Setting Nominal Average Output Current with External Resistor R_S

The nominal average output current in the LED(s) is determined by the value of the external current sense resistor (R_S) connected between VIN and ISENSE and is given by:

$$I_{OUT(NOM)} = \frac{0.1}{R_S}$$

The table below gives values of nominal average output current for several preferred values of current setting resistor (R_S) in the typical application circuit shown on page 1.

R_S (Ω)	Nominal Average Output Current (mA)
0.1	1000
0.13	760
0.15	667
0.3	333

The above values assume that the VSET pin is floating and at a nominal voltage of VREF (1.25V). Note that $R_S = 0.1\Omega$ is the minimum allowed value of sense resistor under these conditions to maintain switch current below the specified maximum value. It is possible to use different values of R_S if the VSET pin is driven from an external voltage.

Capacitor Selection

A low ESR capacitor should be used for input decoupling, as the ESR of this capacitor appears in series with the supply source impedance and lowers overall efficiency. This capacitor has to supply the relatively high peak current to the coil and smooth the current ripple on the input supply.

A minimum value of 4.7 μ F is acceptable if the input source is close to the device, but higher values will improve performance at lower input voltages, especially when the source impedance is high. The input capacitor should be placed as close as possible to the IC.

For maximum stability over temperature and voltage, capacitors with X7R, X5R, or better dielectric are recommended. Capacitors with Y5V dielectric are not suitable for decoupling in this application and should NOT be used.

Inductor Selection

Recommended inductor values for the PAM2861 are in the range 33 μ H to 100 μ H. Higher values of inductance are recommended at higher supply voltages in order to minimize errors due to switching delays, which in increased ripple and lower efficiency. Higher values of inductance also result in a smaller change in output current over the supply voltage range. The inductor should be mounted as close to the device as possible with low resistance connections to the LX and VIN pins. The chosen coil should have a saturation current higher than the peak output current and a continuous current rating above the required mean output current.

The inductor value should be chosen to maintain operating duty cycle and switch 'on'/off times within the specified limits over the supply voltage and load current range. The following equations can be used as a guide.

LX Switch 'On' time

$$T_{ON} = \frac{L\Delta I}{V_{IN} - V_{LED} - I_{LED}(R_S + R_L + R_{LX})}$$

Lx Switch 'Off' time

$$T_{OFF} = \frac{L\Delta I}{V_{LED} + V_D + I_{LED}(R_S + R_L)}$$

Where: L is the coil inductance; R_L is the coil resistance; R_S is the current sense resistance; I_{LED} is the required LED current; ΔI is the coil peak-peak ripple current (Internally set to 0.25 x I_{LED}); V_{IN} is the supply voltage; V_{LED} is the total LED forward voltage; R_{LX} is the switch resistance (0.3 Ω nominal); V_D is the diode forward voltage at the required load current

Application Information (cont.)

Diode Selection

For maximum efficiency and performance, the rectifier (D1) should be a fast low capacitance Schottky diode with low reverse leakage at the maximum operating voltage and temperature. They also provide better efficiency than silicon diodes, due to a combination of lower forward voltage and reduced recovery time.

It is important to select parts with a peak current rating above the peak coil current and a continuous current rating higher than the maximum output load current. It is very important to consider the reverse leakage of the diode when operating above +85°C. Excess leakage will increase the power dissipation in the device and if close to the load may create a thermal runaway condition.

The higher forward voltage and overshoot due to reverse recovery time in silicon diodes will increase the peak voltage on the LX output. If a silicon diode is used, care should be taken to ensure that the total voltage appearing on the LX pin including supply ripple, does not exceed the specified maximum value.

Ordering Information

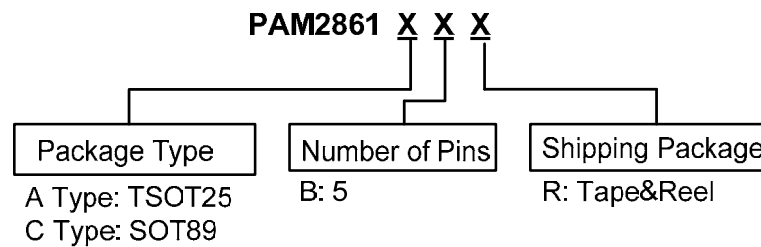

Part Number	Part Marking	Package Type	Standard Package
PAM2861ABR	EQXYW	TSOT25	3000 Units/ Tape&Reel
PAM2861CBR	P2861 XXXYW	SOT89-5	1000 Units/ Tape&Reel

Marking Information

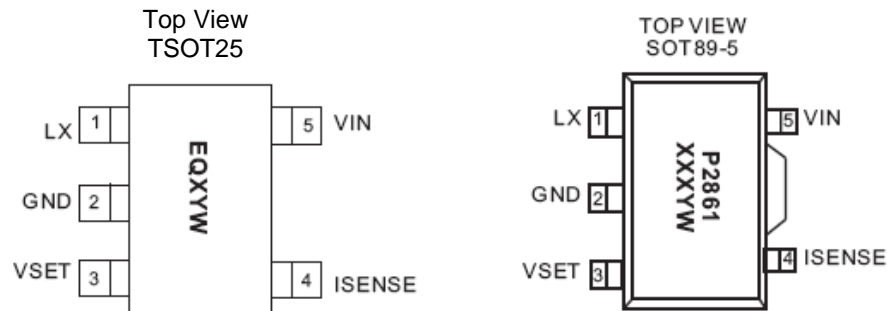

EQ: Product Code of
PAM2861
X: Internal Code
Y: Year
W: Week

Package Outline Dimensions (All dimensions in mm.)

TSOT25

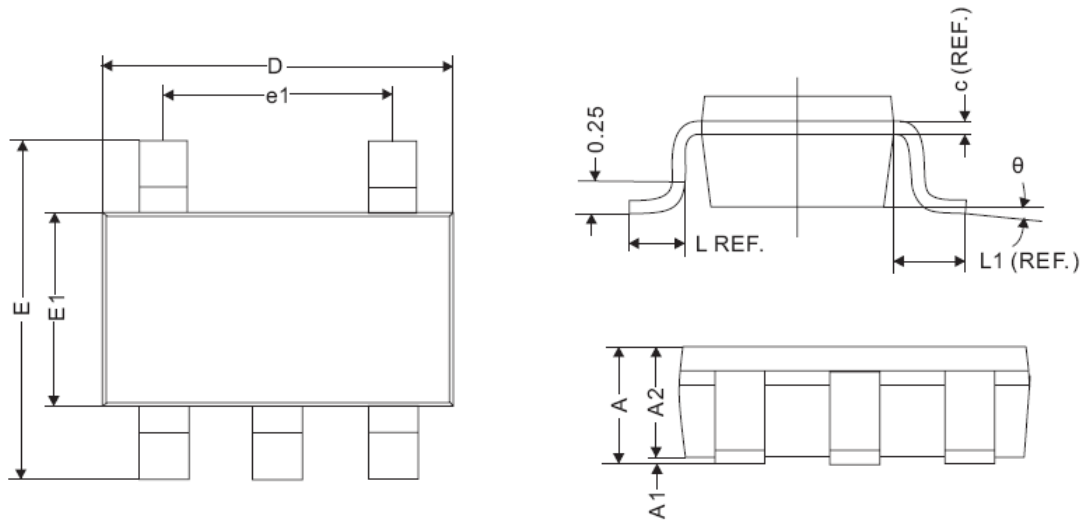

REF.	Millimeter		
	Min	Nom	Max
A	1.10MAX		
A1	0	0.05	0.10
A2	0.70	1.00	1.295
c	0.12REF.		
D	2.70	2.90	3.10
E	2.60	2.80	3.00
E1	1.40	1.60	1.80
L	0.45REF.		
L1	0.60REF.		
theta	0°	5°	10°
b	0.30	0.40	0.50
e	0.95REF.		
e1	1.90REF.		

Package Outline Dimensions (cont.) (All dimensions in mm.)

SOT89-5

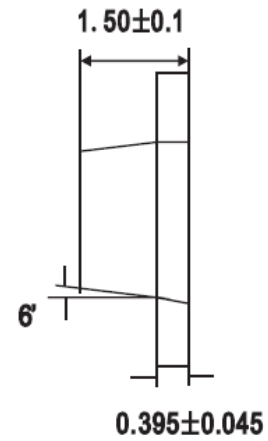
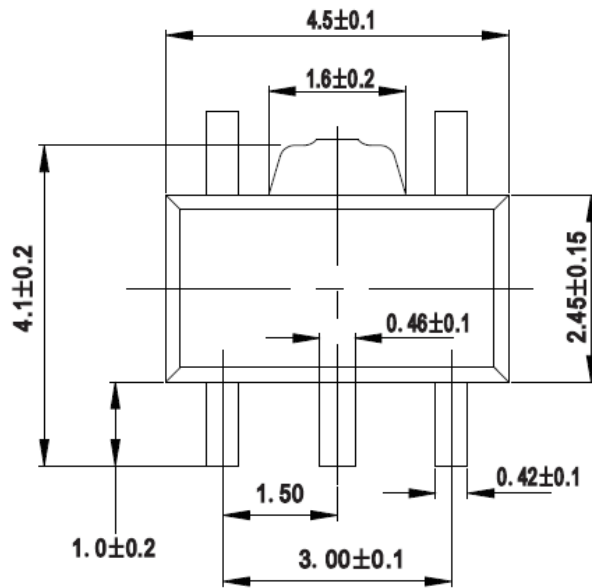

(Unit: mm)

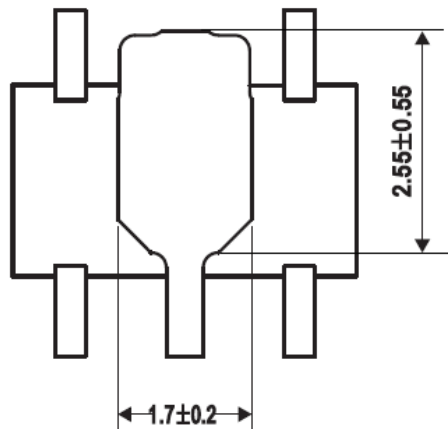

Bottom View

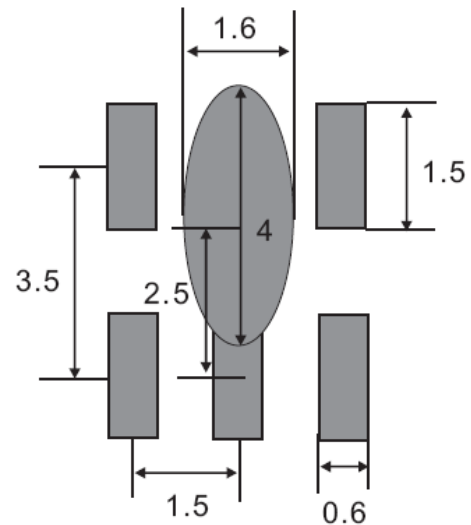

Recommended Land Pattern

IMPORTANT NOTICE

DIODES INCORPORATED MAKES NO WARRANTY OF ANY KIND, EXPRESS OR IMPLIED, WITH REGARDS TO THIS DOCUMENT, INCLUDING, BUT NOT LIMITED TO, THE IMPLIED WARRANTIES OF MERCHANTABILITY AND FITNESS FOR A PARTICULAR PURPOSE (AND THEIR EQUIVALENTS UNDER THE LAWS OF ANY JURISDICTION).

Diodes Incorporated and its subsidiaries reserve the right to make modifications, enhancements, improvements, corrections or other changes without further notice to this document and any product described herein. Diodes Incorporated does not assume any liability arising out of the application or use of this document or any product described herein; neither does Diodes Incorporated convey any license under its patent or trademark rights, nor the rights of others. Any Customer or user of this document or products described herein in such applications shall assume all risks of such use and will agree to hold Diodes Incorporated and all the companies whose products are represented on Diodes Incorporated website, harmless against all damages.

Diodes Incorporated does not warrant or accept any liability whatsoever in respect of any products purchased through unauthorized sales channel. Should Customers purchase or use Diodes Incorporated products for any unintended or unauthorized application, Customers shall indemnify and hold Diodes Incorporated and its representatives harmless against all claims, damages, expenses, and attorney fees arising out of, directly or indirectly, any claim of personal injury or death associated with such unintended or unauthorized application.

Products described herein may be covered by one or more United States, international or foreign patents pending. Product names and markings noted herein may also be covered by one or more United States, international or foreign trademarks.

This document is written in English but may be translated into multiple languages for reference. Only the English version of this document is the final and determinative format released by Diodes Incorporated.

LIFE SUPPORT

Diodes Incorporated products are specifically not authorized for use as critical components in life support devices or systems without the express written approval of the Chief Executive Officer of Diodes Incorporated. As used herein:

A. Life support devices or systems are devices or systems which:

1. are intended to implant into the body, or
2. support or sustain life and whose failure to perform when properly used in accordance with instructions for use provided in the labeling can be reasonably expected to result in significant injury to the user.

B. A critical component is any component in a life support device or system whose failure to perform can be reasonably expected to cause the failure of the life support device or to affect its safety or effectiveness.

Customers represent that they have all necessary expertise in the safety and regulatory ramifications of their life support devices or systems, and acknowledge and agree that they are solely responsible for all legal, regulatory and safety-related requirements concerning their products and any use of Diodes Incorporated products in such safety-critical, life support devices or systems, notwithstanding any devices- or systems-related information or support that may be provided by Diodes Incorporated. Further, Customers must fully indemnify Diodes Incorporated and its representatives against any damages arising out of the use of Diodes Incorporated products in such safety-critical, life support devices or systems.

Copyright © 2013, Diodes Incorporated

www.diodes.com